

SKiIP 28MLI07E3V1

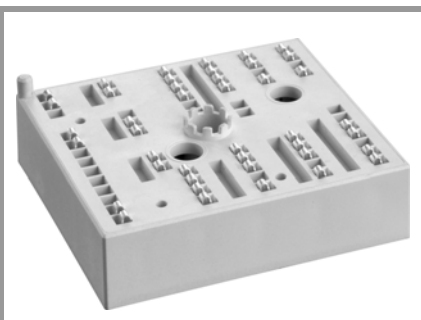

MiniSKiIP® 2

3-Level NPC IGBT-Module

SKiIP 28MLI07E3V1

Features

- 650V Trench IGBTs
- Robust and soft diodes in CAL technology
- Highly reliable spring contacts for electrical connections
- UL recognised: File no. E63532
- NTC T-Sensor

Typical Applications*

- Uninterruptible power supplies (UPS)
- Solar inverters

Remarks

- Case temperature limited to $T_C=125^\circ\text{C}$ max.; $T_C=T_S$ (valid for baseplate-less modules)
- Product reliability results are valid for $T_{jop}=150^\circ\text{C}$

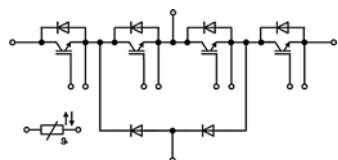

MLI

Absolute Maximum Ratings

Symbol	Conditions	Values	Unit	
IGBT				
V_{CES}		650	V	
I_C	$\lambda_{paste}=0.8 \text{ W/(mK)}$ $T_j = 175^\circ\text{C}$	$T_s = 25^\circ\text{C}$	135	A
		$T_s = 70^\circ\text{C}$	107	A
I_C	$\lambda_{paste}=2.5 \text{ W/(mK)}$ $T_j = 175^\circ\text{C}$	$T_s = 25^\circ\text{C}$	163	A
		$T_s = 70^\circ\text{C}$	130	A
I_{Cnom}		150	A	
I_{CRM}	$I_{CRM} = 3 \times I_{Cnom}$	450	A	
V_{GES}		-20 ... 20	V	
t_{psc}	$V_{CC} = 360 \text{ V}$ $V_{GE} \leq 15 \text{ V}$ $V_{CES} \leq 650 \text{ V}$	$T_j = 150^\circ\text{C}$	6	μs
T_j		-40 ... 175	$^\circ\text{C}$	
Inverse diode				
I_F	$\lambda_{paste}=0.8 \text{ W/(mK)}$ $T_j = 175^\circ\text{C}$	$T_s = 25^\circ\text{C}$	126	A
		$T_s = 70^\circ\text{C}$	97	A
I_F	$\lambda_{paste}=2.5 \text{ W/(mK)}$ $T_j = 175^\circ\text{C}$	$T_s = 25^\circ\text{C}$	151	A
		$T_s = 70^\circ\text{C}$	118	A
I_{Fnom}		150	A	
I_{FRM}	$I_{FRM} = 2 \times I_{Fnom}$	300	A	
I_{FSM}	$t_p = 10 \text{ ms, sin } 180^\circ, T_j = 25^\circ\text{C}$	1200	A	
T_j		-40 ... 175	$^\circ\text{C}$	
Clamping diode				
I_F	$\lambda_{paste}=0.8 \text{ W/(mK)}$ $T_j = 175^\circ\text{C}$	$T_s = 25^\circ\text{C}$	126	A
		$T_s = 70^\circ\text{C}$	97	A
I_F	$\lambda_{paste}=2.5 \text{ W/(mK)}$ $T_j = 175^\circ\text{C}$	$T_s = 25^\circ\text{C}$	151	A
		$T_s = 70^\circ\text{C}$	118	A
I_{Fnom}		150	A	
I_{FRM}	$I_{FRM} = 2 \times I_{Fnom}$	300	A	
I_{FSM}	10 ms, sin 180°, $T_j = 25^\circ\text{C}$	1200	A	
T_j		-40 ... 175	$^\circ\text{C}$	
Module				
$I_{t(RMS)}$	$T_{terminal} = 80^\circ\text{C}, 20\text{A per spring}$	120	A	
T_{stg}		-40 ... 125	$^\circ\text{C}$	
V_{isol}	AC sinus 50 Hz, $t = 1 \text{ min}$	2500	V	

Characteristics

Symbol	Conditions	min.	typ.	max.	Unit
IGBT					
$V_{CE(sat)}$	$I_C = 150 \text{ A}$ $V_{GE} = 15 \text{ V}$ chipelevel	$T_j = 25^\circ\text{C}$	1.45	1.90	V
		$T_j = 150^\circ\text{C}$	1.70	2.10	V
V_{CE0}	chipelevel	$T_j = 25^\circ\text{C}$	0.90	1.00	V
		$T_j = 150^\circ\text{C}$	0.82	0.90	V
r_{CE}	$V_{GE} = 15 \text{ V}$ chipelevel	$T_j = 25^\circ\text{C}$	3.7	6.0	m Ω
		$T_j = 150^\circ\text{C}$	5.9	8.0	m Ω
$V_{GE(th)}$	$V_{GE} = V_{CE}, I_C = 2.4 \text{ mA}$	5.1	5.8	6.4	V
I_{CES}	$V_{GE} = 0 \text{ V}$ $V_{CE} = 650 \text{ V}$	$T_j = 25^\circ\text{C}$	0.1	0.3	mA
			-	-	mA
C_{ies}	$V_{CE} = 25 \text{ V}$	$f = 1 \text{ MHz}$	9.24		nF
C_{oes}	$V_{GE} = 0 \text{ V}$	$f = 1 \text{ MHz}$	0.58		nF
C_{res}		$f = 1 \text{ MHz}$	0.27		nF

SKiIP 28MLI07E3V1

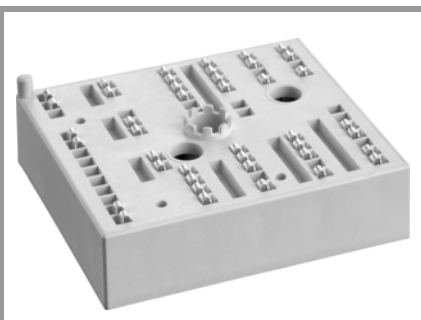

MiniSKiIP® 2

3-Level NPC IGBT-Module

SKiIP 28MLI07E3V1

Features

- 650V Trench IGBTs
- Robust and soft diodes in CAL technology
- Highly reliable spring contacts for electrical connections
- UL recognised: File no. E63532
- NTC T-Sensor

Typical Applications*

- Uninterruptible power supplies (UPS)
- Solar inverters

Remarks

- Case temperature limited to $T_C=125^\circ\text{C}$ max.; $T_C=T_S$ (valid for baseplate-less modules)
- Product reliability results are valid for $T_{jop}=150^\circ\text{C}$

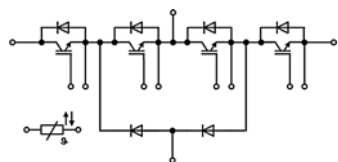

MLI

Characteristics						
Symbol	Conditions	min.	typ.	max.	Unit	
IGBT						
Q_G	$V_{GE} = -8 \text{ V...} + 15 \text{ V}$		1200		nC	
R_{Gint}	$T_j = 25^\circ\text{C}$		2.0		Ω	
T1 / T4						
$t_{d(on)}$	$V_{CE} = 300 \text{ V}$	$T_j = 150^\circ\text{C}$	108		ns	
t_r	$I_C = 150 \text{ A}$	$T_j = 150^\circ\text{C}$	73		ns	
E_{on}	$V_{GE} = +15/-15 \text{ V}$	$T_j = 150^\circ\text{C}$	5.5		mJ	
$t_{d(off)}$	$R_{G on} = 3 \Omega$	$T_j = 150^\circ\text{C}$	268		ns	
t_f	$R_{G off} = 1.6 \Omega$	$T_j = 150^\circ\text{C}$	76		ns	
E_{off}	$di/dt_{on} = 2100 \text{ A}/\mu\text{s}$	$T_j = 150^\circ\text{C}$	5.6		mJ	
$R_{th(j-s)}$	per IGBT, $\lambda_{paste}=0.8 \text{ W}/(\text{mK})$		0.55		K/W	
$R_{th(j-s)}$	per IGBT, $\lambda_{paste}=2.5 \text{ W}/(\text{mK})$		0.41		K/W	
T2 / T3						
$t_{d(on)}$	$V_{CE} = 300 \text{ V}$	$T_j = 150^\circ\text{C}$	106		ns	
t_r	$I_C = 150 \text{ A}$	$T_j = 150^\circ\text{C}$	64		ns	
E_{on}	$V_{GE} = +15/-15 \text{ V}$	$T_j = 150^\circ\text{C}$	2		mJ	
$t_{d(off)}$	$R_{G on} = 3 \Omega$	$T_j = 150^\circ\text{C}$	268		ns	
t_f	$R_{G off} = 1.6 \Omega$	$T_j = 150^\circ\text{C}$	77		ns	
E_{off}	$di/dt_{on} = 2520 \text{ A}/\mu\text{s}$	$T_j = 150^\circ\text{C}$	5.2		mJ	
$R_{th(j-s)}$	per IGBT, $\lambda_{paste}=0.8 \text{ W}/(\text{mK})$		0.55		K/W	
$R_{th(j-s)}$	per IGBT, $\lambda_{paste}=2.5 \text{ W}/(\text{mK})$		0.41		K/W	
Inverse diode						
$V_F = V_{EC}$	$I_F = 150 \text{ A}$	$T_j = 25^\circ\text{C}$	1.40	1.76	V	
	$V_{GE} = 0 \text{ V}$	$T_j = 150^\circ\text{C}$	1.39	1.77	V	
	chipelevel	$T_j = 25^\circ\text{C}$	1.04	1.24	V	
		$T_j = 150^\circ\text{C}$	0.85	0.99	V	
r_F	chipelevel	$T_j = 25^\circ\text{C}$	2.4	3.5	m Ω	
		$T_j = 150^\circ\text{C}$	3.6	5.2	m Ω	
I_{RRM}	$I_F = 150 \text{ A}$	$T_j = 150^\circ\text{C}$	121		A	
Q_{rr}	$di/dt_{off} = 2450 \text{ A}/\mu\text{s}$	$T_j = 150^\circ\text{C}$	20		μC	
E_{rr}	$V_{GE} = -15 \text{ V}$	$T_j = 150^\circ\text{C}$	5.5		mJ	
$R_{th(j-s)}$	per Diode, $\lambda_{paste}=0.8 \text{ W}/(\text{mK})$		0.75		K/W	
$R_{th(j-s)}$	per Diode, $\lambda_{paste}=2.5 \text{ W}/(\text{mK})$		0.58		K/W	
Clamping diode						
$V_F = V_{EC}$	$I_F = 150 \text{ A}$	$T_j = 25^\circ\text{C}$	1.40	1.76	V	
	$V_{GE} = 0 \text{ V}$	$T_j = 150^\circ\text{C}$	1.39	1.77	V	
	chipelevel	$T_j = 25^\circ\text{C}$	1.04	1.24	V	
		$T_j = 150^\circ\text{C}$	0.85	0.99	V	
r_F	chipelevel	$T_j = 25^\circ\text{C}$	2.4	3.5	m Ω	
		$T_j = 150^\circ\text{C}$	3.6	5.2	m Ω	
I_{RRM}	$I_F = 150 \text{ A}$	$T_j = 150^\circ\text{C}$	116		A	
Q_{rr}	$di/dt_{off} = 2210 \text{ A}/\mu\text{s}$	$T_j = 150^\circ\text{C}$	13.2		μC	
E_{rr}	$V_{GE} = -15 \text{ V}$	$T_j = 150^\circ\text{C}$	2.6		mJ	
$R_{th(j-s)}$	per Diode, $\lambda_{paste}=0.8 \text{ W}/(\text{mK})$		0.75		K/W	
$R_{th(j-s)}$	per Diode, $\lambda_{paste}=2.5 \text{ W}/(\text{mK})$		0.58		K/W	
Module						
M_s	to heat sink		2	2.5	Nm	
w	weight		55		g	
Temperature Sensor						
R_{25}	NTC, $T_r = 25^\circ\text{C}^1)$		5.0 \pm 5%		k Ω	

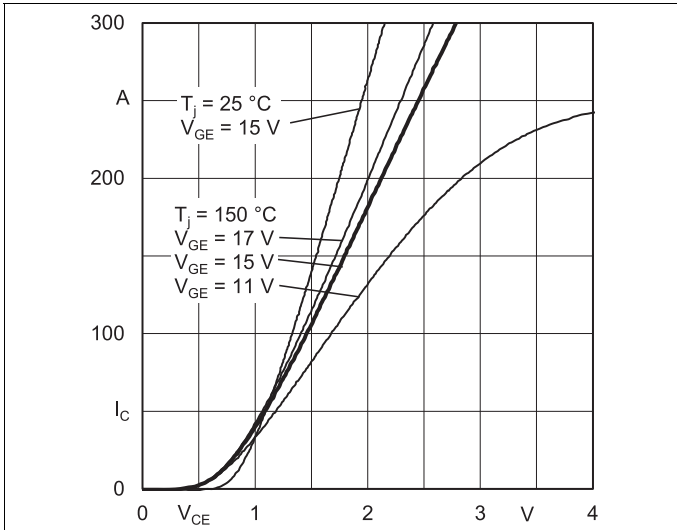

Fig. 1: Typ. output characteristic, inclusive R_{CC+EE}

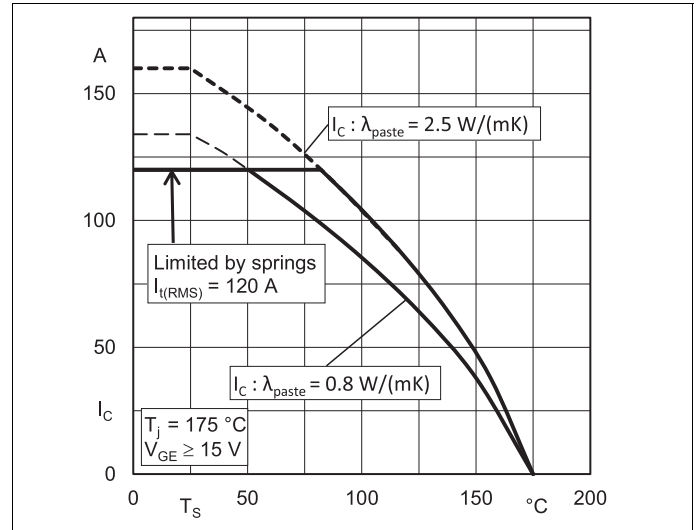

Fig. 2: Rated current vs. temperature $I_C = f(T_s)$

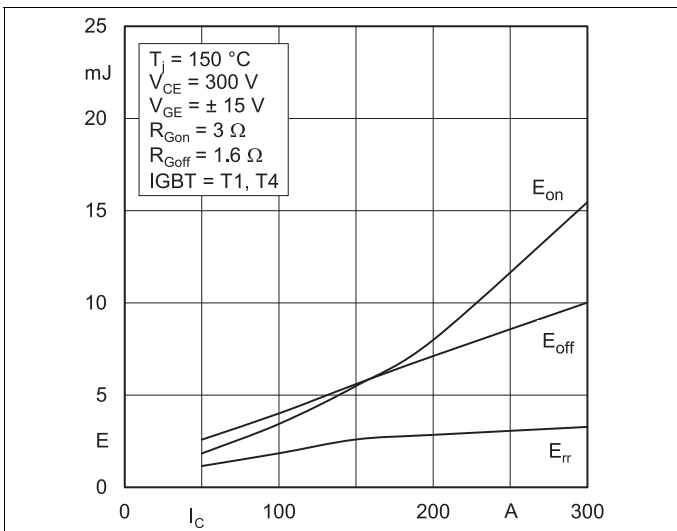

Fig. 3: Typ. turn-on /-off energy = $f(I_C)$

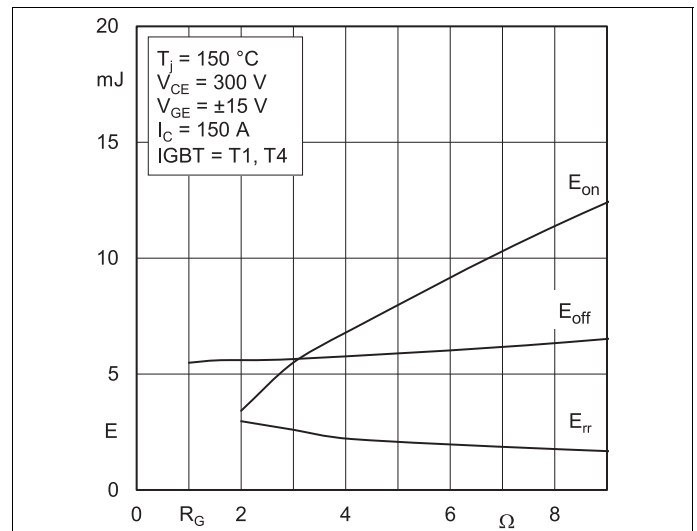

Fig. 4: Typ. turn-on /-off energy = $f(R_G)$

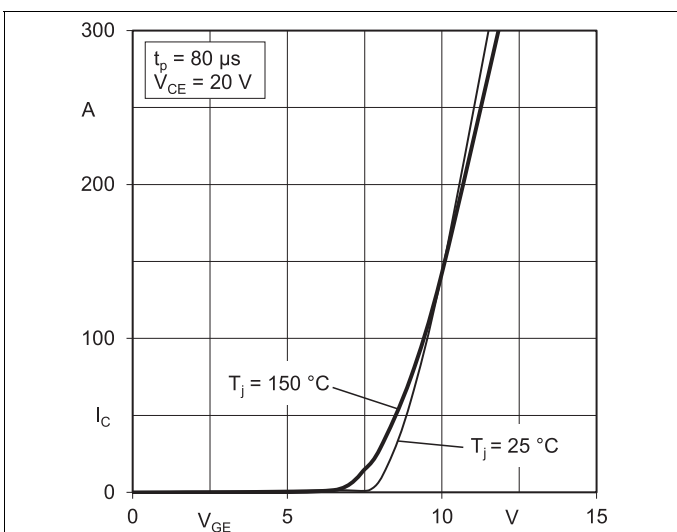

Fig. 5: Typ. transfer characteristic

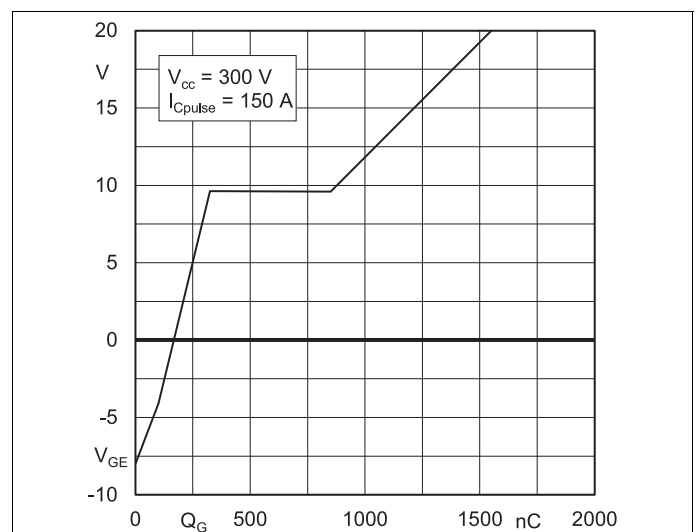
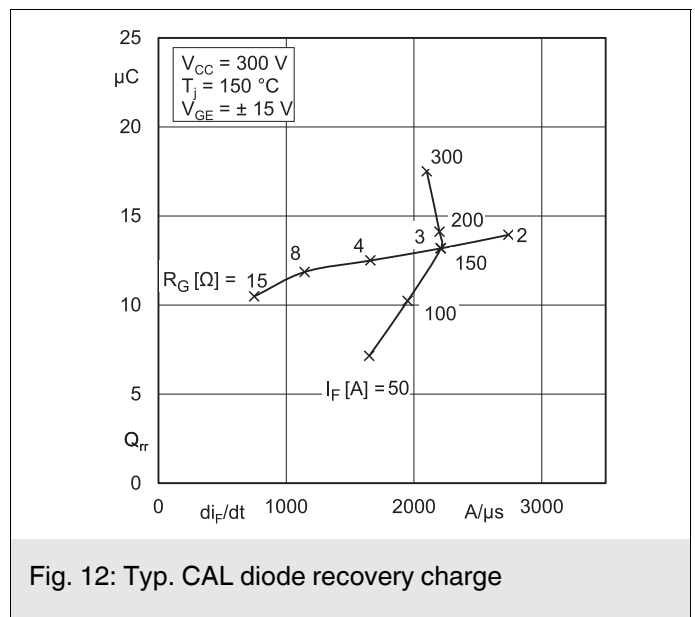
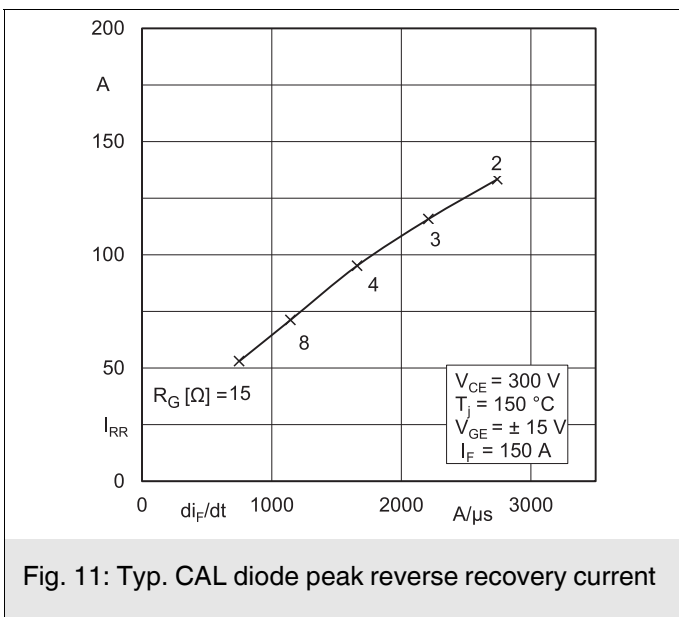
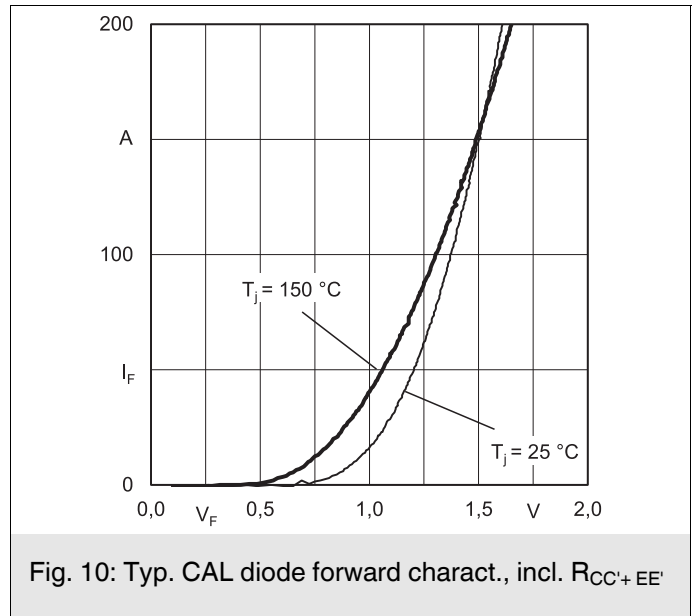
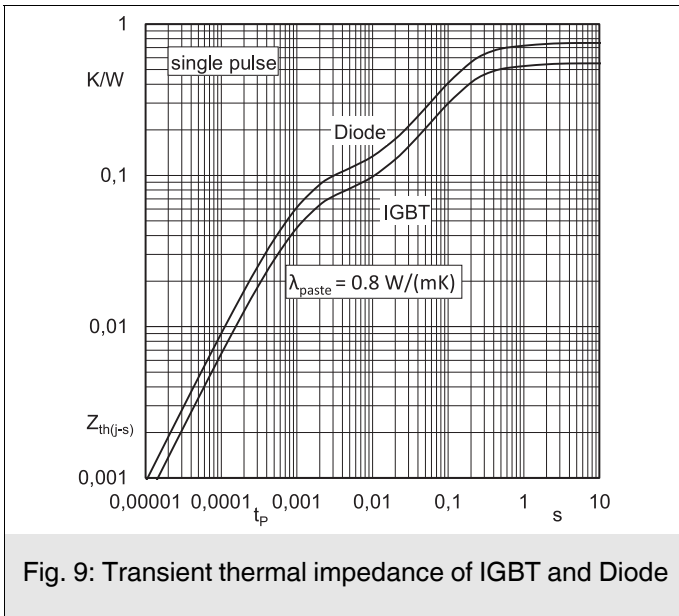
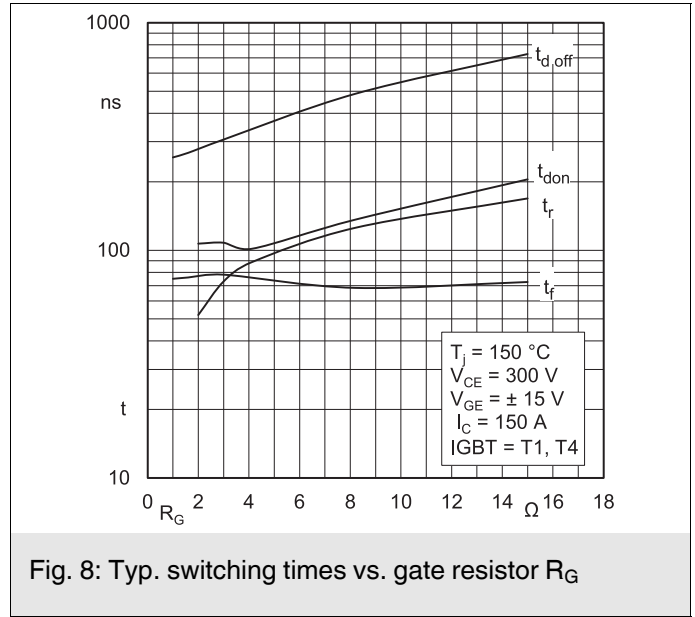
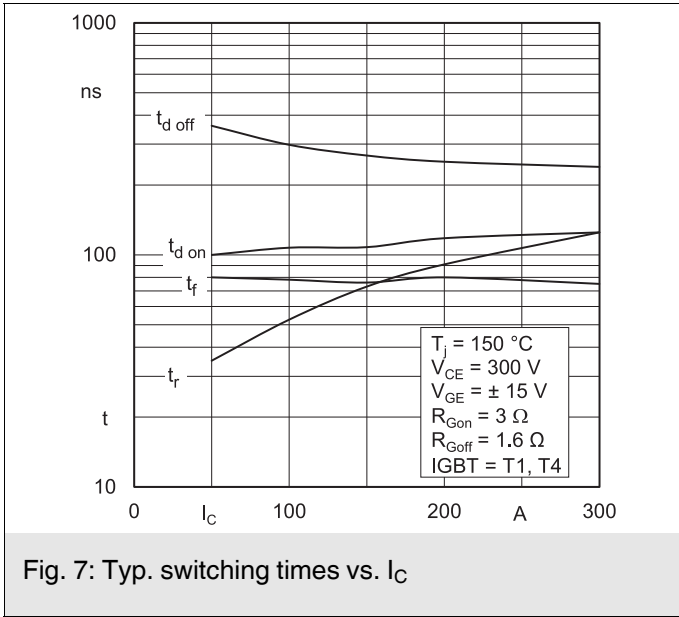
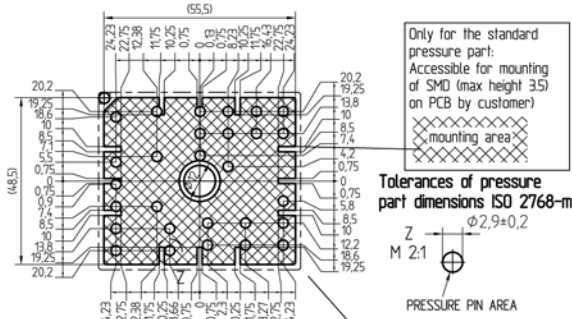

Fig. 6: Typ. gate charge characteristic



PCB
PCB TOP-VIEW



MiniSKiIP 2

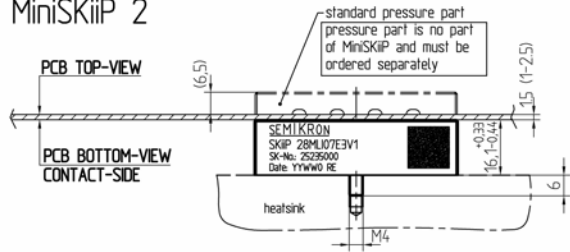

PCB TOP-VIEW
PCB BOTTOM-VIEW CONTACT-SIDE
PCB BOTTOM-VIEW CONTACT-SIDE ISO 2768-f

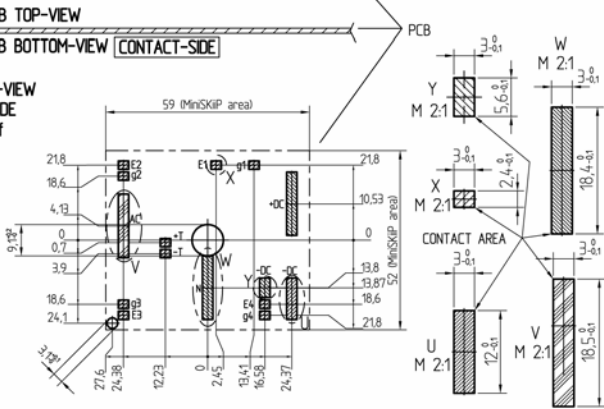

pinout, dimensions

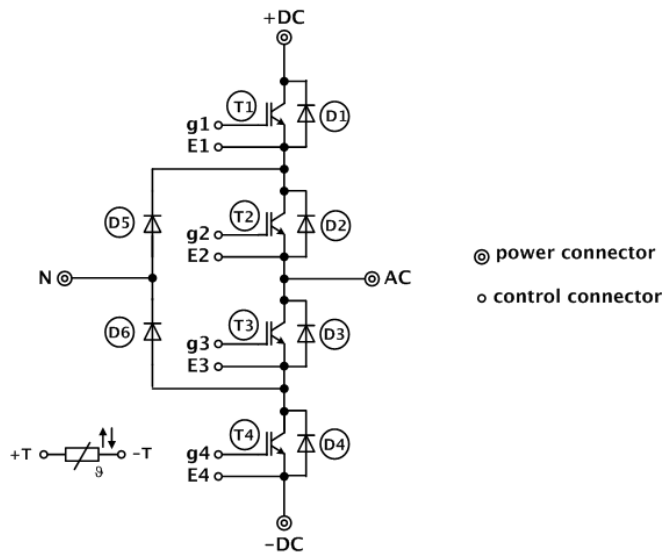

pinout

This is an electrostatic discharge sensitive device (ESDS), international standard IEC 60747-1, chapter IX.

***IMPORTANT INFORMATION AND WARNINGS**

The specifications of SEMIKRON products may not be considered as guarantee or assurance of product characteristics ("Beschaffenheitsgarantie"). The specifications of SEMIKRON products describe only the usual characteristics of products to be expected in typical applications, which may still vary depending on the specific application. Therefore, products must be tested for the respective application in advance. Application adjustments may be necessary. The user of SEMIKRON products is responsible for the safety of their applications embedding SEMIKRON products and must take adequate safety measures to prevent the applications from causing a physical injury, fire or other problem if any of SEMIKRON products become faulty. The user is responsible to make sure that the application design is compliant with all applicable laws, regulations, norms and standards. Except as otherwise explicitly approved by SEMIKRON in a written document signed by authorized representatives of SEMIKRON, SEMIKRON products may not be used in any applications where a failure of the product or any consequences of the use thereof can reasonably be expected to result in personal injury. No representation or warranty is given and no liability is assumed with respect to the accuracy, completeness and/or use of any information herein, including without limitation, warranties of non-infringement of intellectual property rights of any third party. SEMIKRON does not assume any liability arising out of the applications or use of any product; neither does it convey any license under its patent rights, copyrights, trade secrets or other intellectual property rights, nor the rights of others. SEMIKRON makes no representation or warranty of non-infringement or alleged non-infringement of intellectual property rights of any third party which may arise from applications. Due to technical requirements our products may contain dangerous substances. For information on the types in question please contact the nearest SEMIKRON sales office. This document supersedes and replaces all information previously supplied and may be superseded by updates. SEMIKRON reserves the right to make changes.