

SKiiP 03NEB066V3

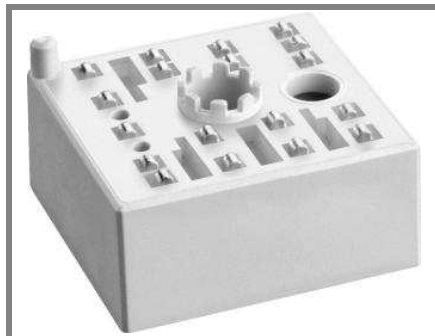

MiniSKiiP® 0

1-phase bridge rectifier +
brake chopper + 3-phase
bridge inverter
SKiiP 03NEB066V3

Features

- Trench IGBTs
- Robust and soft freewheeling diodes in CAL technology
- Highly reliable spring contacts for electrical connections
- UL recognised file no. E63532

Typical Applications*

- Inverter up to 5,6 kVA
- Typical motor power 3,0 kW

Remarks

- Case temperature limited to $T_C = 125^\circ\text{C}$ max.
- Product reliability results are valid for $T_j = 150^\circ\text{C}$
- SC data: $t_p \leq 6 \mu\text{s}$; $V_{GE} \leq 15 \text{ V}$; $T_j = 150^\circ\text{C}$; $V_{CC} = 360 \text{ V}$
- V_{CEsat} , $V_F =$ chip level value

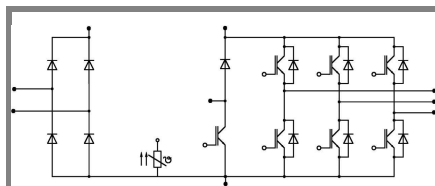

NEB

Absolute Maximum Ratings		$T_s = 25^\circ\text{C}$, unless otherwise specified	
Symbol	Conditions	Values	Units
IGBT - Inverter, Chopper			
V_{CES}		600	V
I_C	$T_s = 25 (70)^\circ\text{C}$, $T_j = 150^\circ\text{C}$	25 (17)	A
I_C	$T_s = 25 (70)^\circ\text{C}$, $T_j = 175^\circ\text{C}$	27 (21)	A
I_{CRM}	$t_p = 1 \text{ ms}$	30	A
V_{GES}		± 20	V
Diode - Inverter, Chopper			
I_F	$T_s = 25 (70)^\circ\text{C}$, $T_j = 150^\circ\text{C}$	24 (16)	A
I_F	$T_s = 25 (70)^\circ\text{C}$, $T_j = 175^\circ\text{C}$	28 (21)	A
I_{FRM}	$t_p = 1 \text{ ms}$	30	A
Diode - Rectifier			
V_{RRM}		800	V
I_F	$T_s = 70^\circ\text{C}$	35	A
I_{FSM}	$t_p = 10 \text{ ms}$, $\sin 180^\circ$, $T_j = 25^\circ\text{C}$	220	A
i^2t	$t_p = 10 \text{ ms}$, $\sin 180^\circ$, $T_j = 25^\circ\text{C}$	240	A^2s
I_{tRMS}	per power terminal (20 A / spring)	20	A
T_j	IGBT, Diode	$-40 \dots +175$	$^\circ\text{C}$
T_{stg}		$-40 \dots +125$	$^\circ\text{C}$
V_{isol}	AC, 1 min.	2500	V

Characteristics		$T_s = 25^\circ\text{C}$, unless otherwise specified			
Symbol	Conditions	min.	typ.	max.	Units
IGBT - Inverter, Chopper					
$V_{CE(sat)}$	$I_{Cnom} = 15 \text{ A}$, $T_j = 25 (150)^\circ\text{C}$	1,45 (1,65)	1,85 (2,05)		V
$V_{GE(th)}$	$V_{GE} = V_{CE}$, $I_C = 1 \text{ mA}$	5,8			V
$V_{CE(TO)}$	$T_j = 25 (150)^\circ\text{C}$	0,9 (0,85)	1 (0,9)		V
r_{CE}	$T_j = 25 (150)^\circ\text{C}$	40 (57)	60 (80)		$\text{m}\Omega$
C_{ies}	$V_{CE} = 25 \text{ V}$, $V_{GE} = 0 \text{ V}$, $f = 1 \text{ MHz}$	0,86			nF
C_{oes}	$V_{CE} = 25 \text{ V}$, $V_{GE} = 0 \text{ V}$, $f = 1 \text{ MHz}$	0,18			nF
C_{res}	$V_{CE} = 25 \text{ V}$, $V_{GE} = 0 \text{ V}$, $f = 1 \text{ MHz}$	0,12			nF
$R_{CC+EE'}$	spring contact-chip $T_s = 25 (150)^\circ\text{C}$				$\text{m}\Omega$
$R_{th(j-s)}$	per IGBT	1,8			K/W
$t_{d(on)}$	under following conditions	20			ns
t_r	$V_{CC} = 300 \text{ V}$, $V_{GE} = \pm 15 \text{ V}$	30			ns
$t_{d(off)}$	$I_{Cnom} = 15 \text{ A}$, $T_j = 150^\circ\text{C}$	155			ns
t_f	$R_{Gon} = R_{Goff} = 22 \Omega$	45			ns
$E_{on} (E_{off})$	inductive load	0,6 (0,5)			mJ
Diode - Inverter, Chopper					
$V_F = V_{EC}$	$I_F = 15 \text{ A}$, $T_j = 25 (150)^\circ\text{C}$	1,4 (1,4)	1,7 (1,7)		V
$V_{(TO)}$	$T_j = 25 (150)^\circ\text{C}$	1 (0,9)	1,1 (1)		V
r_T	$T_j = 25 (150)^\circ\text{C}$	27 (34)	40 (47)		$\text{m}\Omega$
$R_{th(j-s)}$	per diode	2,5			K/W
I_{RRM}	under following conditions	19,8			A
Q_{rr}	$I_{Fnom} = 15 \text{ A}$, $V_R = 300 \text{ V}$	1,9			μC
E_{rr}	$V_{GE} = 0 \text{ V}$, $T_j = 150^\circ\text{C}$	0,5			mJ
	$di_F/dt = 930 \text{ A}/\mu\text{s}$				
Diode - Rectifier					
V_F	$I_{Fnom} = 15 \text{ A}$, $T_j = 25^\circ\text{C}$	1,1			V
$V_{(TO)}$	$T_j = 150^\circ\text{C}$	0,8			V
r_T	$T_j = 150^\circ\text{C}$	20			$\text{m}\Omega$
$R_{th(j-s)}$	per diode	1,5			K/W
Temperature Sensor					
R_{ts}	3 %, $T_r = 25 (100)^\circ\text{C}$	1000(1670)			Ω
Mechanical Data					
w		21,5			g
M_s	Mounting torque	2	2,5		Nm

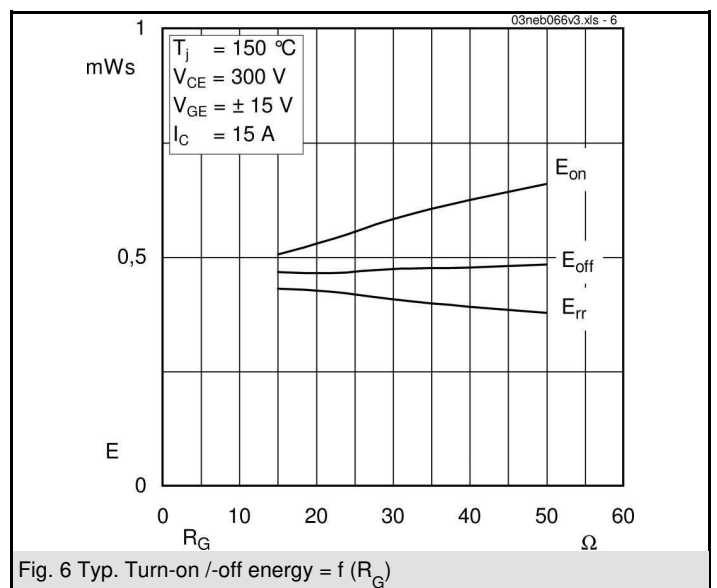
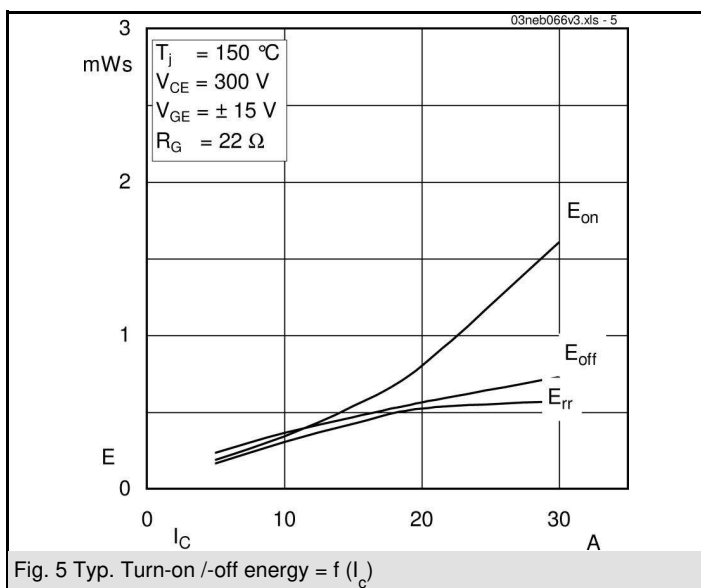
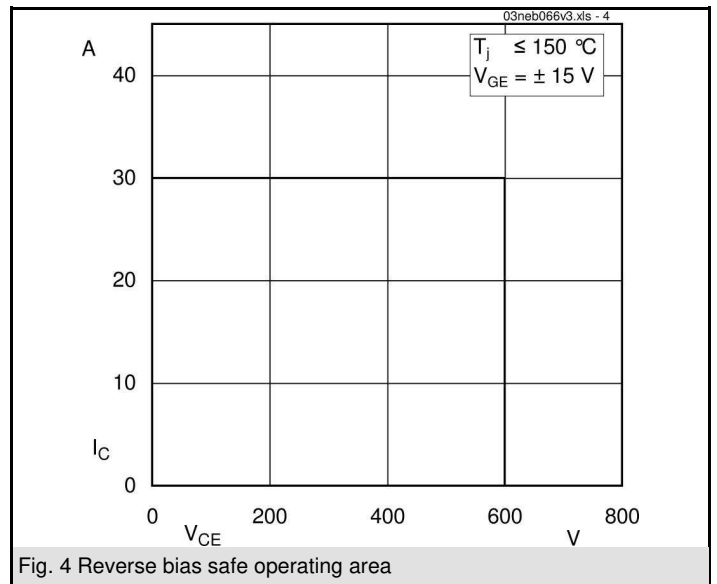
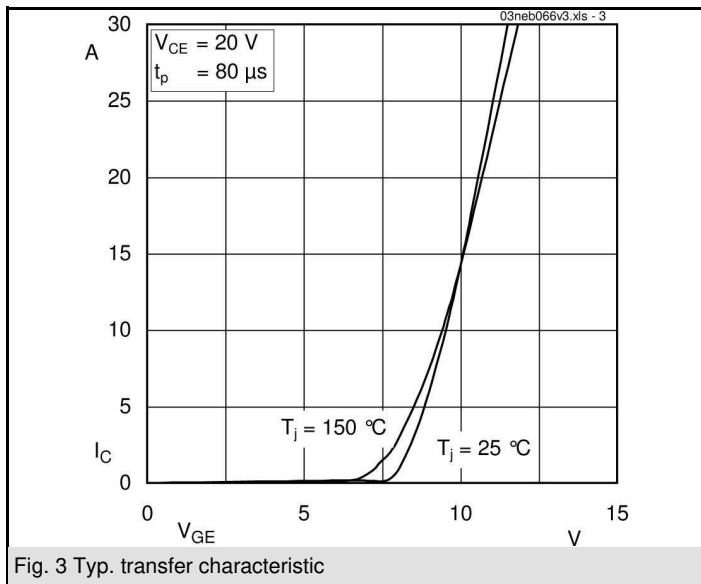
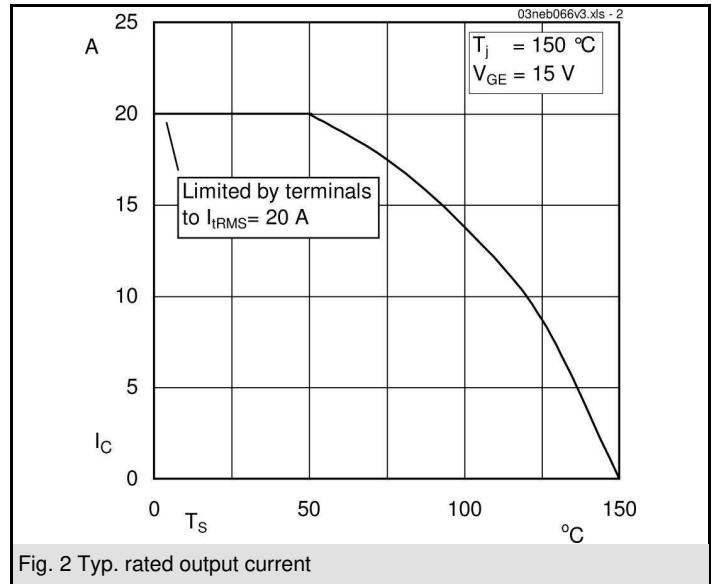
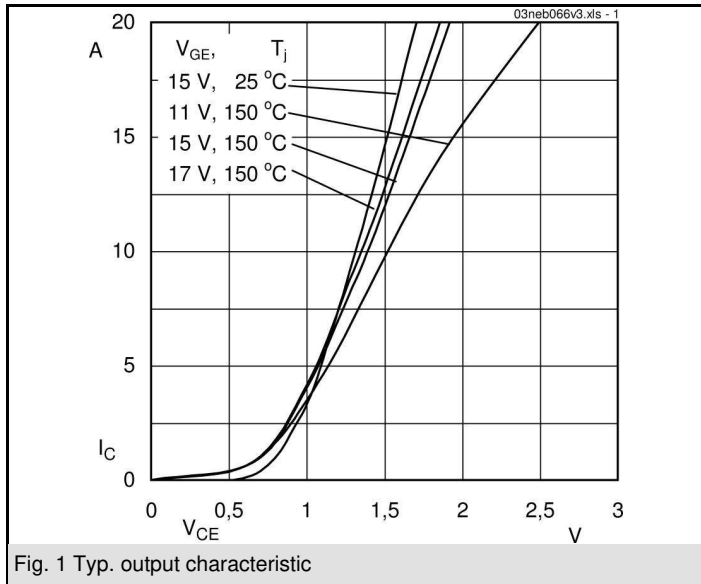

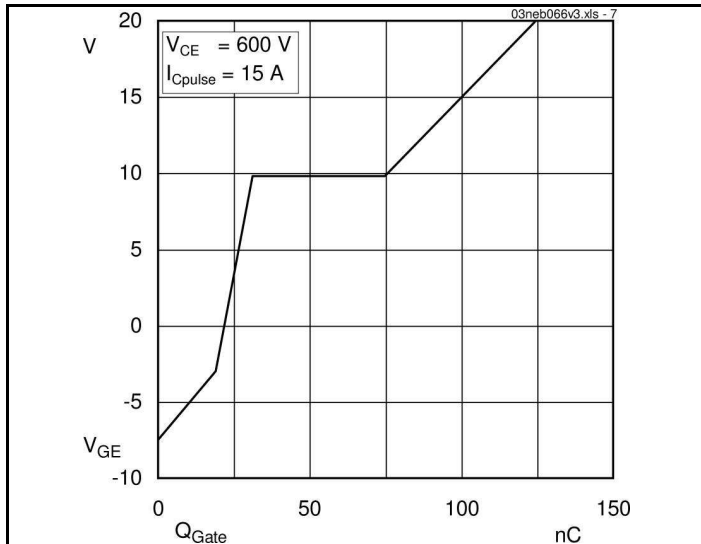

Fig. 7 Typ. gate charge characteristic

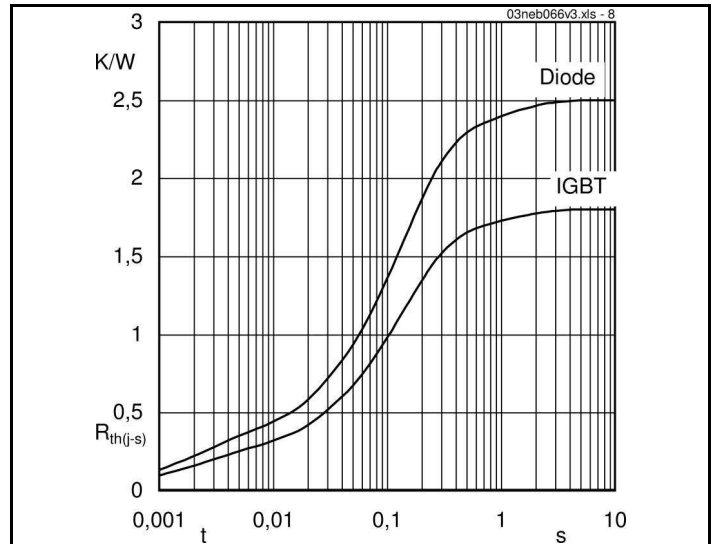

Fig. 8 Typ. thermal impedance

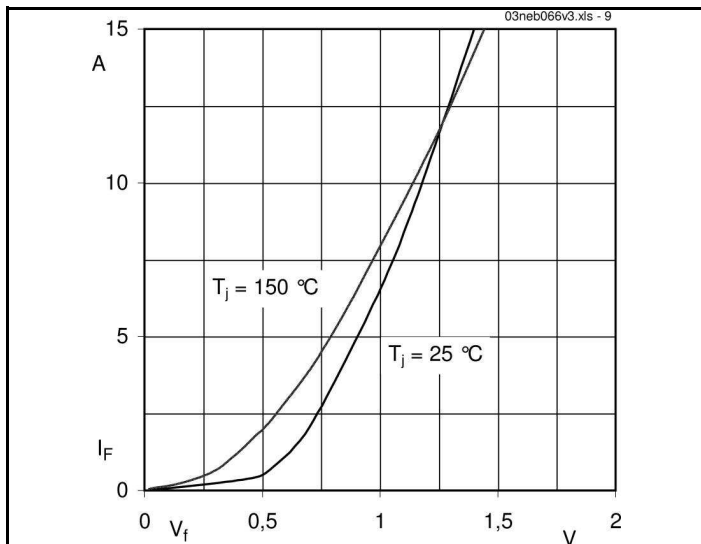

Fig. 9 Typ. freewheeling diode forward characteristic

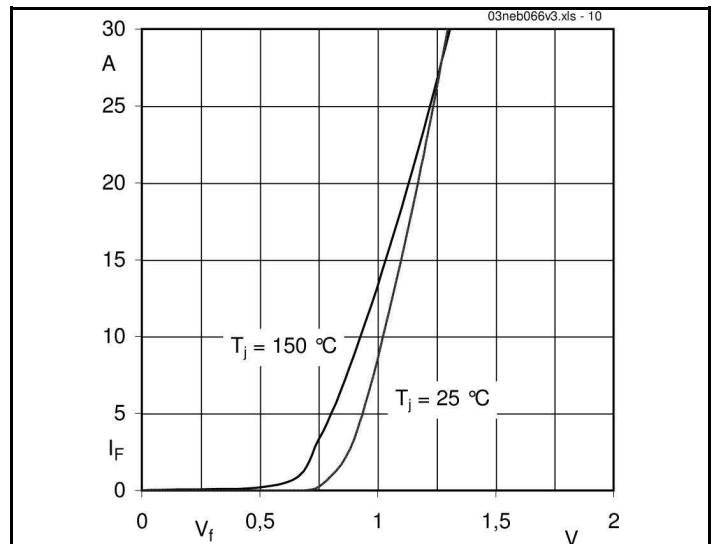
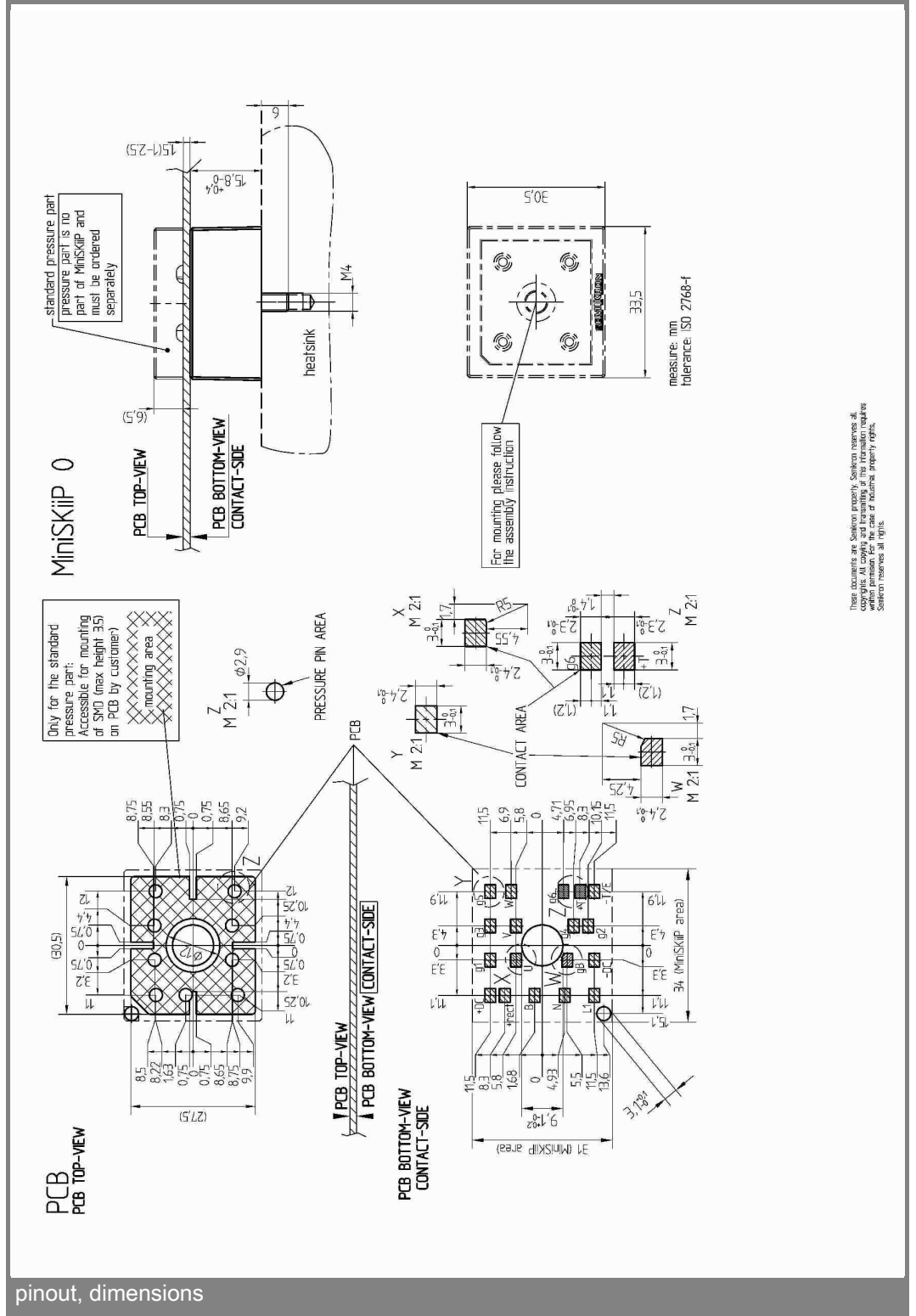
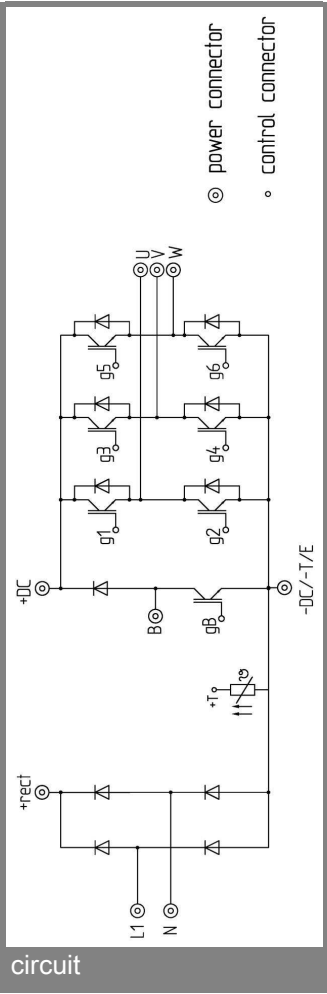

Fig. 10 Typ. input bridge forward characteristic



These documents are Semikron property. Copying, reuse or distribution without written permission for the case of industrial property rights. Semikron reserves all rights.

This is an electrostatic discharge sensitive device (ESDS), international standard IEC 60747-1, Chapter IX.

* The specifications of our components may not be considered as an assurance of component characteristics. Components have to be tested for the respective application. Adjustments may be necessary. The use of SEMIKRON products in life support appliances and systems is subject to prior specification and written approval by SEMIKRON. We therefore strongly recommend prior consultation of our personal.