

SKiiP 12AC12T4V1

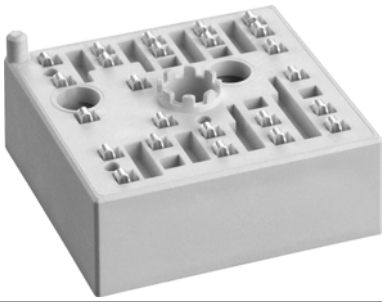

MiniSKiiP® 1

SKiiP 12AC12T4V1

Features

- Trench 4 IGBT's
- Robust and soft freewheeling diodes in CAL technology
- Highly reliable spring contacts for electrical connections
- UL recognised file no. E63532

Typical Applications*

- Inverter up to 12 kVA
- Typical motor power 5,5 kW

Remarks

- V_{CEsat} , V_F = chip level value
- Case temp. limited to $T_C = 125^\circ\text{C}$ max. (for baseplateless modules $T_C = T_S$)
- product rel. results valid for $T_j \leq 150$ (recomm. $T_{op} = -40 \dots +150^\circ\text{C}$)

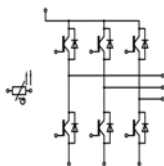

AC

Absolute Maximum Ratings				
Symbol	Conditions		Values	Unit
Inverter - IGBT				
V_{CES}	$T_j = 25^\circ\text{C}$		1200	V
I_C	$T_j = 175^\circ\text{C}$	$T_s = 25^\circ\text{C}$	18	A
		$T_s = 70^\circ\text{C}$	18	A
I_{Cnom}			15	A
I_{CRM}	$I_{CRM} = 3 \times I_{Cnom}$		45	A
V_{GES}			-20 ... 20	V
t_{psc}	$V_{CC} = 800\text{ V}$	$T_j = 150^\circ\text{C}$	10	μs
	$V_{GE} \leq 15\text{ V}$ $V_{CES} \leq 1200\text{ V}$			
T_j			-40 ... 175	$^\circ\text{C}$
Inverse - Diode				
I_F	$T_j = 175^\circ\text{C}$	$T_s = 25^\circ\text{C}$	23	A
		$T_s = 70^\circ\text{C}$	18	A
I_{Fnom}			15	A
I_{FRM}	$I_{FRM} = 3 \times I_{Fnom}$		45	A
I_{FSM}	10 ms, sin 180°, $T_j = 150^\circ\text{C}$		65	A
T_j			-40 ... 175	$^\circ\text{C}$
Module				
$I_{t(RMS)}$	$T_{terminal} = 80^\circ\text{C}$, 20A per spring		20	A
T_{stg}			-40 ... 125	$^\circ\text{C}$
V_{isol}	AC sinus 50Hz, t = 1 min		2500	V

Characteristics						
Symbol	Conditions		min.	typ.	max.	Unit
Inverter - IGBT						
$V_{CE(sat)}$	$I_C = 15\text{ A}$ $V_{GE} = 15\text{ V}$ chipllevel	$T_j = 25^\circ\text{C}$	1.85	2.10		V
		$T_j = 150^\circ\text{C}$	2.25	2.45		V
V_{CE0}						
	$T_j = 25^\circ\text{C}$		0.8	0.9		V
r_{CE}	$V_{GE} = 15\text{ V}$	$T_j = 25^\circ\text{C}$	70	80		m Ω
		$T_j = 150^\circ\text{C}$	103	110		m Ω
$V_{GE(th)}$	$V_{GE} = V_{CE}$, $I_C = 1\text{ mA}$		5	5.8	6.5	V
I_{CES}	$V_{GE} = 0\text{ V}$ $V_{CE} = 1200\text{ V}$	$T_j = 25^\circ\text{C}$	0.1	0.3		mA
						mA
C_{ies}				0.90		nF
C_{oes}	$V_{CE} = 25\text{ V}$ $V_{GE} = 0\text{ V}$	$f = 1\text{ MHz}$		0.08		nF
C_{res}		$f = 1\text{ MHz}$		0.06		nF
Q_G	- 8 V...+ 15 V			85		nC
R_{Gint}	$T_j = 25^\circ\text{C}$			0.00		Ω
$t_{d(on)}$	$V_{CC} = 600\text{ V}$	$T_j = 150^\circ\text{C}$		31		ns
t_r	$I_C = 15\text{ A}$	$T_j = 150^\circ\text{C}$		30		ns
E_{on}	$R_{Gon} = 39\ \Omega$ $R_{Goff} = 39\ \Omega$	$T_j = 150^\circ\text{C}$		1.65		mJ
$t_{d(off)}$	$di/dt_{on} = 400\text{ A}/\mu\text{s}$	$T_j = 150^\circ\text{C}$		315		ns
t_f	$di/dt_{off} = 200\text{ A}/\mu\text{s}$	$T_j = 150^\circ\text{C}$		66		ns
E_{off}	$V_{GE} = +15/-15\text{ V}$	$T_j = 150^\circ\text{C}$		1.5		mJ
$R_{th(j-s)}$	per IGBT			1.3		K/W

SKiiP 12AC12T4V1

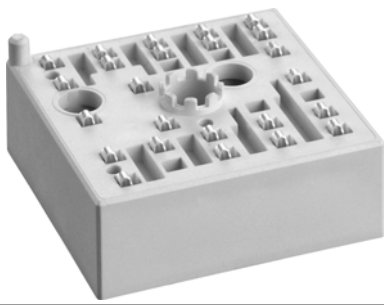

MiniSKiiP® 1

SKiiP 12AC12T4V1

Features

- Trench 4 IGBT's
- Robust and soft freewheeling diodes in CAL technology
- Highly reliable spring contacts for electrical connections
- UL recognised file no. E63532

Typical Applications*

- Inverter up to 12 kVA
- Typical motor power 5,5 kW

Remarks

- V_{CEsat} , V_F = chip level value
- Case temp. limited to $T_C = 125^\circ\text{C}$ max. (for baseplateless modules $T_C = T_S$)
- product rel. results valid for $T_j \leq 150$ (recomm. $T_{op} = -40 \dots +150^\circ\text{C}$)

Characteristics						
Symbol	Conditions		min.	typ.	max.	Unit
Inverse - Diode						
$V_F = V_{EC}$	$I_F = 15 \text{ A}$ $V_{GE} = 0 \text{ V}$ chiplevel	$T_j = 25^\circ\text{C}$		2.4	2.7	V
		$T_j = 150^\circ\text{C}$		2.4	2.8	V
V_{F0}		$T_j = 25^\circ\text{C}$		1.3	1.5	V
		$T_j = 150^\circ\text{C}$		0.9	1.1	V
r_F		$T_j = 25^\circ\text{C}$		72	81	m Ω
		$T_j = 150^\circ\text{C}$		103	111	m Ω
I_{RRM}	$I_F = 15 \text{ A}$	$T_j = 150^\circ\text{C}$		12		A
Q_{rr}	$di/dt_{off} = 500 \text{ A}/\mu\text{s}$	$T_j = 150^\circ\text{C}$		2		μC
E_{rr}	$V_{GE} = -15 \text{ V}$ $V_{CC} = 600 \text{ V}$	$T_j = 150^\circ\text{C}$		0.79		mJ
$R_{th(j-s)}$	per Diode			1.92		K/W
Module						
M_s	to heat sink		2		2.5	Nm
w				35		g
Temperatur Sensor						
R_{100}	$T_C = 100^\circ\text{C}$ ($R_{25} = 1000\Omega$)			$1670 \pm 3\%$		Ω
$R(T)$	$R(T) = 1000\Omega [1 + A(T - 25^\circ\text{C}) + B(T - 25^\circ\text{C})^2]$], $A = 7.635 \cdot 10^{-3} \text{ }^\circ\text{C}^{-1}$, $B = 1.731 \cdot 10^{-5} \text{ }^\circ\text{C}^{-2}$					

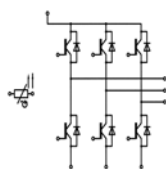

AC

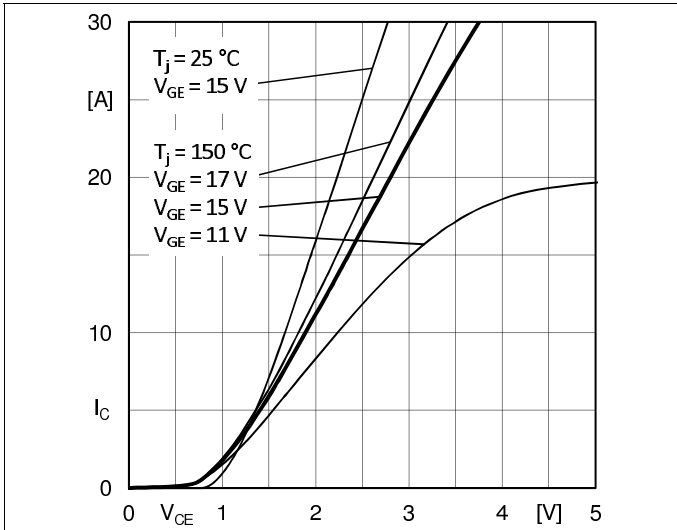

Fig. 1: Typ. output characteristic, inclusive R_{CC+EE}

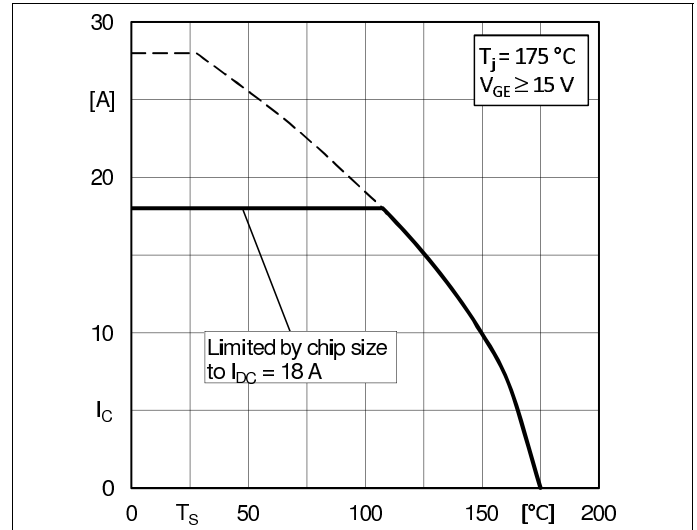

Fig. 2: Rated current vs. temperature $I_C = f(T_S)$

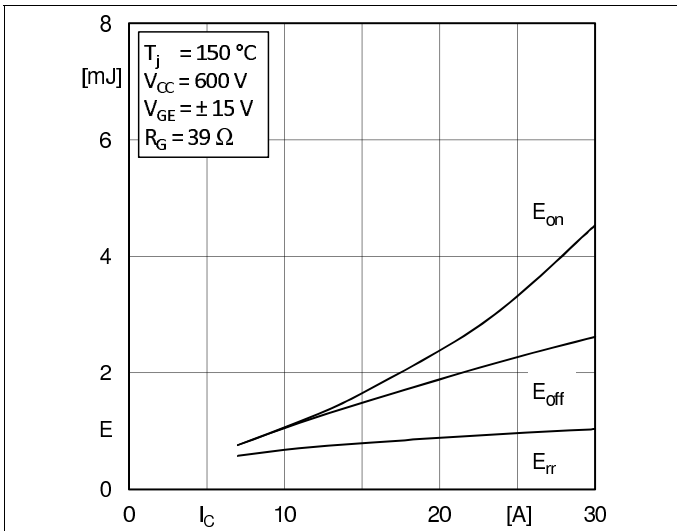

Fig. 3: Typ. turn-on /-off energy = $f(I_C)$

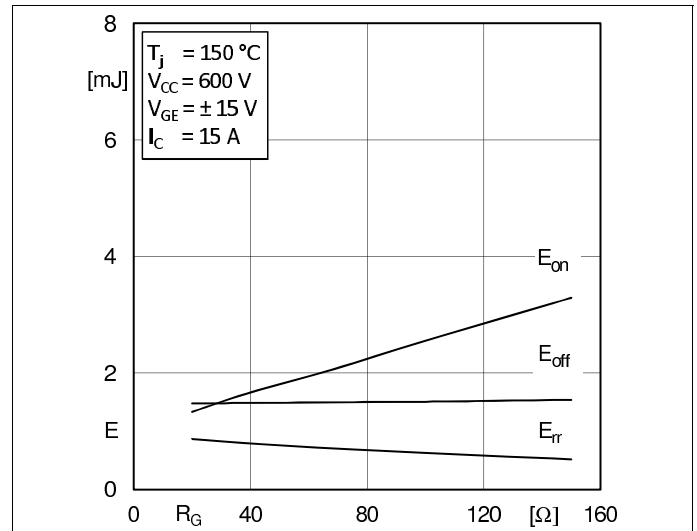

Fig. 4: Typ. turn-on /-off energy = $f(R_G)$

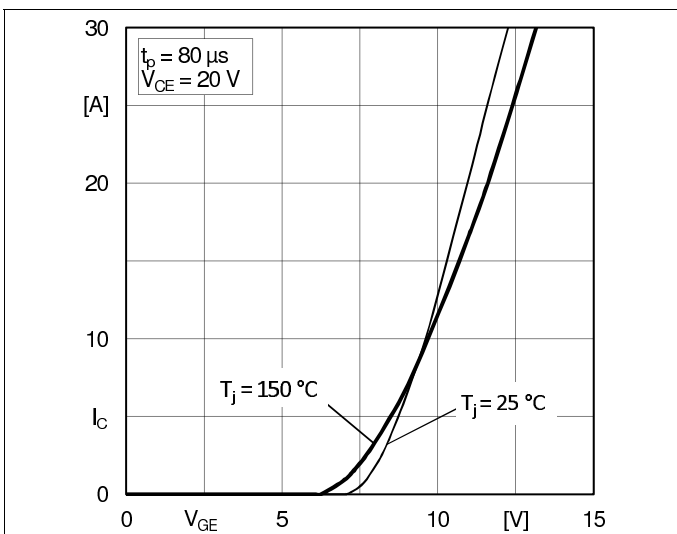

Fig. 5: Typ. transfer characteristic

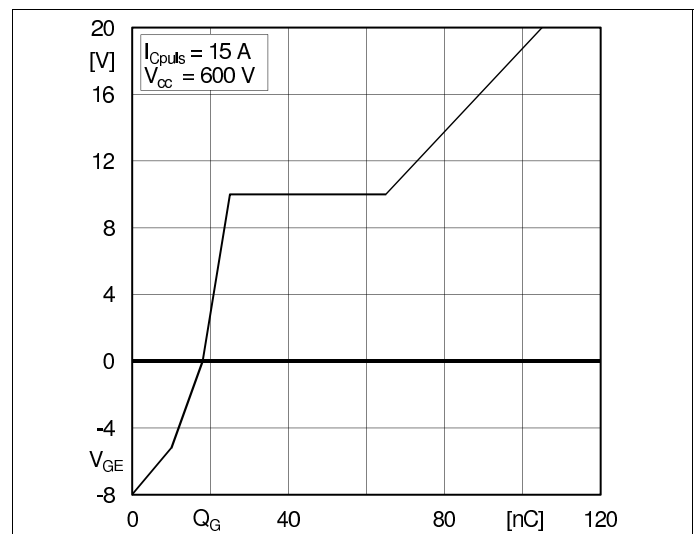

Fig. 6: Typ. gate charge characteristic

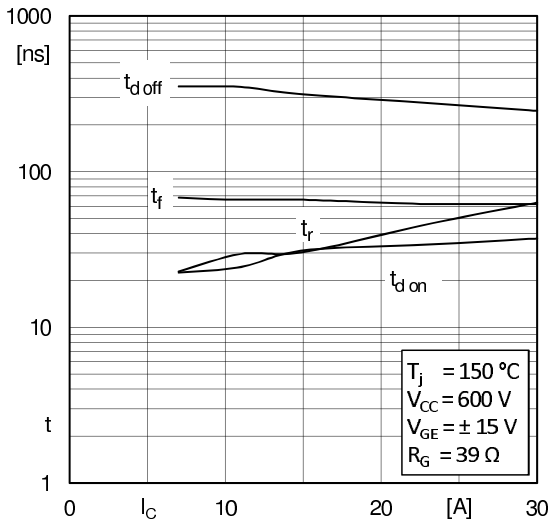

Fig. 7: Typ. switching times vs. I_c

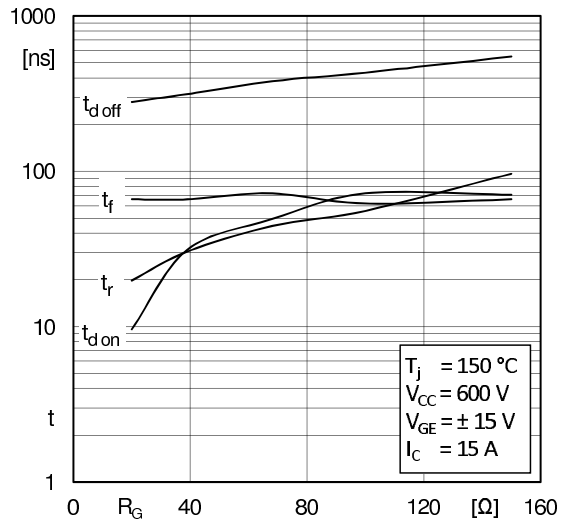

Fig. 8: Typ. switching times vs. gate resistor R_G

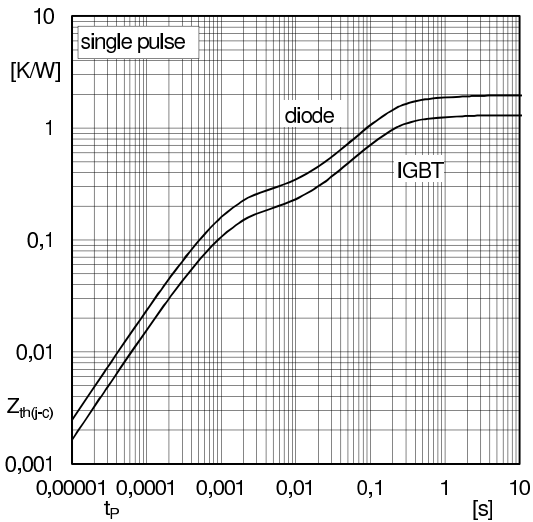

Fig. 9: Transient thermal impedance of IGBT and Diode

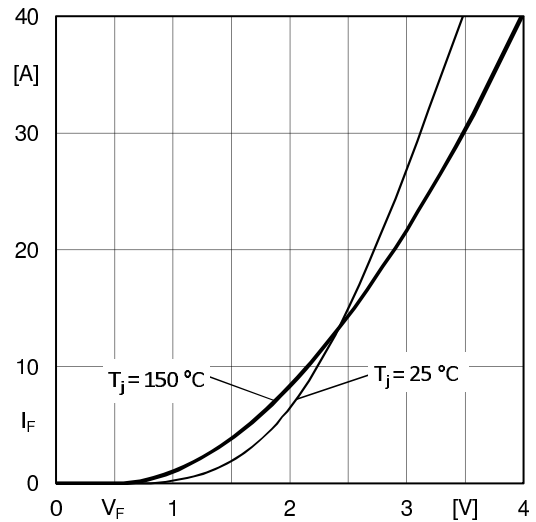

Fig. 10: CAL diode forward characteristic

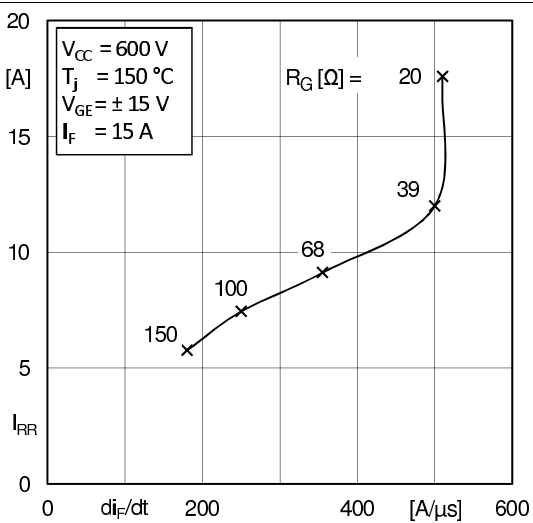

Fig. 11: Typ. CAL diode peak reverse recovery current

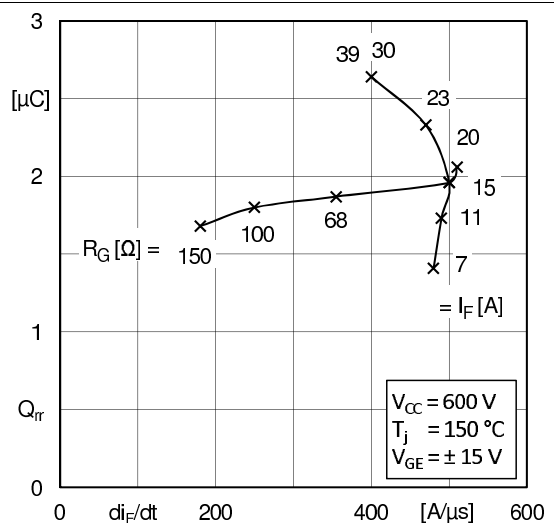
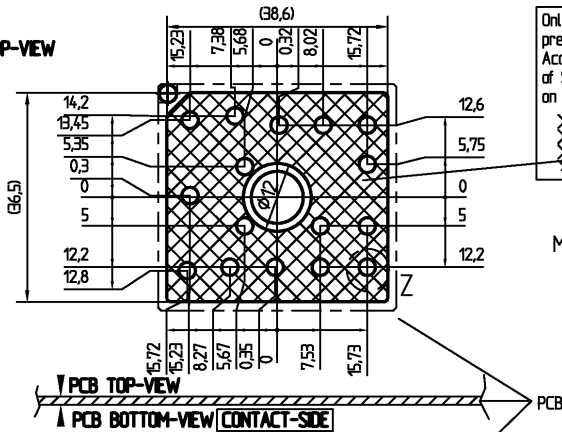

Fig. 12: Typ. CAL diode recovery charge

PCB PCB TOP-VIEW



Only for the standard pressure part:
Accessible for mounting of SMD (max height 3.5) on PCB by customer



mounting area

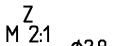

PRESSURE PIN AREA

MiniSKiiP 1

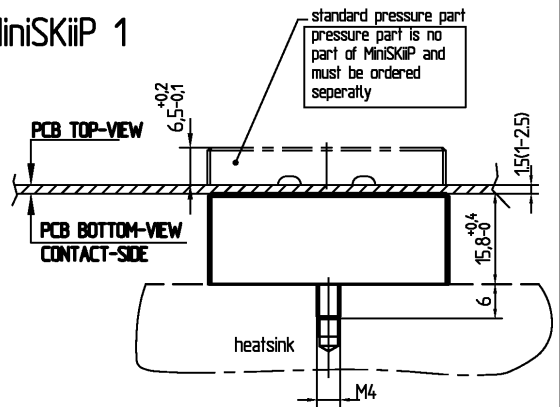

PCB BOTTOM-VIEW CONTACT-SIDE

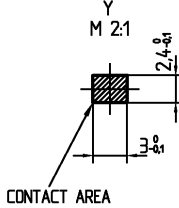
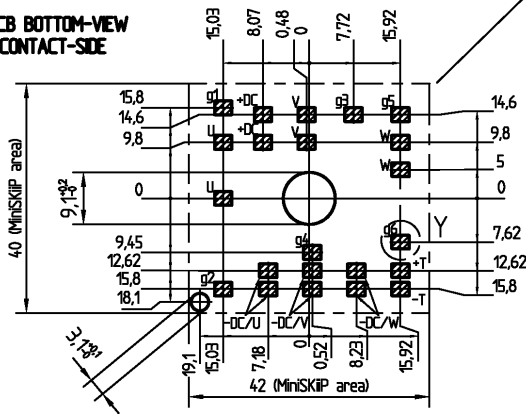

For mounting please follow the assembly instruction

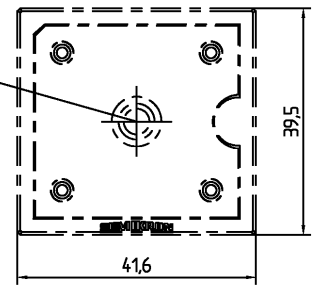

measure: mm
tolerance: ISO 2768-f

pinout, dimensions

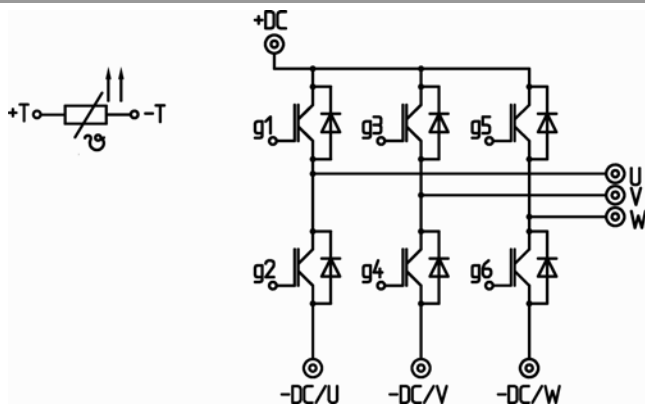

- ⊙ power connector
- control connector

pinout

This is an electrostatic discharge sensitive device (ESDS), international standard IEC 60747-1, Chapter IX

* The specifications of our components may not be considered as an assurance of component characteristics. Components have to be tested for the respective application. Adjustments may be necessary. The use of SEMIKRON products in life support appliances and systems is subject to prior specification and written approval by SEMIKRON. We therefore strongly recommend prior consultation of our staff.