

SKiiP 38AC126V2

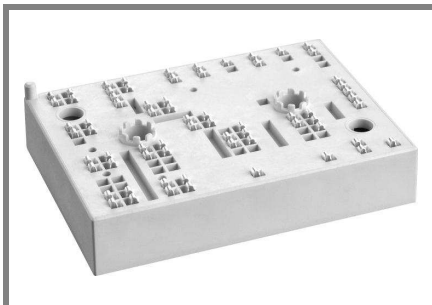

MiniSKiiP® 3

3-phase bridge inverter

SKiiP 38AC126V2

Features

- Fast Trench IGBTs
- Robust and soft freewheeling diodes in CAL technology
- Highly reliable spring contacts for electrical connections
- UL recognised file no. E63532

Typical Applications*

- Inverter up to 39 kVA
- Typical motor power 22 kW

Remarks

- V_{CEsat} , V_F = chip level value

| Absolute Maximum Ratings | | $T_s = 25\text{ °C}$, unless otherwise specified | |
|--------------------------|---|---|-------|
| Symbol | Conditions | Values | Units |
| IGBT - Inverter | | | |
| V_{CES} | $T_s = 25\text{ (70) °C}$ $t_p \leq 1\text{ ms}$ | 1200 | V |
| I_C | | 118 (88) | A |
| I_{CRM} | | 210 | A |
| V_{GES} | | ± 20 | V |
| T_j | | - 40 ... + 150 | °C |
| Diode - Inverter | | | |
| I_F | $T_s = 25\text{ (70) °C}$ $t_p \leq 1\text{ ms}$ | 118 (88) | A |
| I_{FRM} | | 210 | A |
| T_j | | - 40 ... + 150 | °C |
| I_{tRMS} | per power terminal (20 A / spring) | 160 | A |
| T_{stg} | $T_{op} \leq T_{stg}$ | - 40 ... + 125 | °C |
| V_{isol} | AC, 1 min. | 2500 | V |

| Characteristics | | $T_s = 25\text{ °C}$, unless otherwise specified | | | |
|---------------------------|---|---|------------|-----------|-------|
| Symbol | Conditions | min. | typ. | max. | Units |
| IGBT - Inverter | | | | | |
| V_{CEsat} | $I_{Cnom} = 105\text{ A}$, $T_j = 25\text{ (125) °C}$ | | 1,7 (2) | 2,1 (2,4) | V |
| $V_{GE(th)}$ | $V_{GE} = V_{CE}$, $I_C = 3\text{ mA}$ | 5 | 5,8 | 6,5 | V |
| $V_{CE(TO)}$ | $T_j = 25\text{ (125) °C}$ | | 1 (0,9) | 1,2 (1,1) | V |
| r_T | $T_j = 25\text{ (125) °C}$ | | 6,7 (10) | 8,6 (12) | mΩ |
| C_{ies} | $V_{CE} = 25\text{ V}$, $V_{GE} = 0\text{ V}$, $f = 1\text{ MHz}$ | | 8,4 | | nF |
| C_{oes} | $V_{CE} = 25\text{ V}$, $V_{GE} = 0\text{ V}$, $f = 1\text{ MHz}$ | | 1,5 | | nF |
| C_{res} | $V_{CE} = 25\text{ V}$, $V_{GE} = 0\text{ V}$, $f = 1\text{ MHz}$ | | 1,1 | | nF |
| $R_{th(j-s)}$ | per IGBT | | 0,4 | | K/W |
| $t_{d(on)}$ | under following conditions | | 75 | | ns |
| t_r | $V_{CC} = 600\text{ V}$, $V_{GE} = \pm 15\text{ V}$ | | 35 | | ns |
| $t_{d(off)}$ | $I_{Cnom} = 105\text{ A}$, $T_j = 125\text{ °C}$ | | 465 | | ns |
| t_f | $R_{Gon} = R_{Goff} = 5\text{ Ω}$ | | 90 | | ns |
| E_{on} | inductive load | | 13,1 | | mJ |
| E_{off} | | | 13 | | mJ |
| Diode - Inverter | | | | | |
| $V_F = V_{EC}$ | $I_{Fnom} = 105\text{ A}$, $T_j = 25\text{ (125) °C}$ | | 1,6 (1,6) | 1,8 (1,8) | V |
| $V_{(TO)}$ | $T_j = 25\text{ (125) °C}$ | | 1 (0,8) | 1,1 (0,9) | V |
| r_T | $T_j = 25\text{ (125) °C}$ | | 5,7 (7,6) | 6,7 (8,6) | mΩ |
| $R_{th(j-s)}$ | per diode | | 0,55 | | K/W |
| I_{RRM} | under following conditions | | 175 | | A |
| Q_{rr} | $I_{Fnom} = 105\text{ A}$, $V_R = 600\text{ V}$ | | 26 | | μC |
| E_{rr} | $V_{GE} = 0\text{ V}$, $T_j = 125\text{ °C}$ | | 11,2 | | mJ |
| | $di_F/dt = 4000\text{ A/μs}$ | | | | |
| Temperature Sensor | | | | | |
| R_{ts} | 3 %, $T_r = 25\text{ (100) °C}$ | | 1000(1670) | | Ω |
| Mechanical Data | | | | | |
| m | | | 95 | | g |
| M_s | Mounting torque | 2 | | 2,5 | Nm |

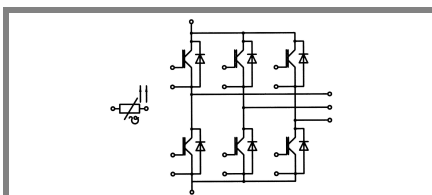

AC

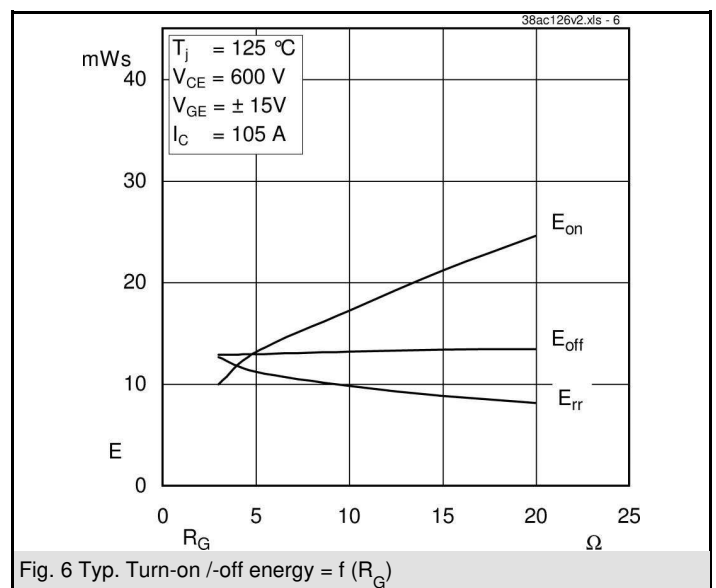
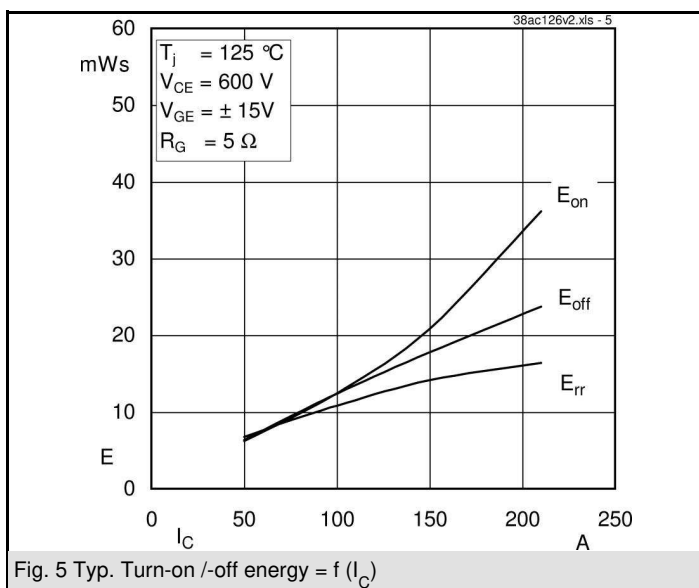
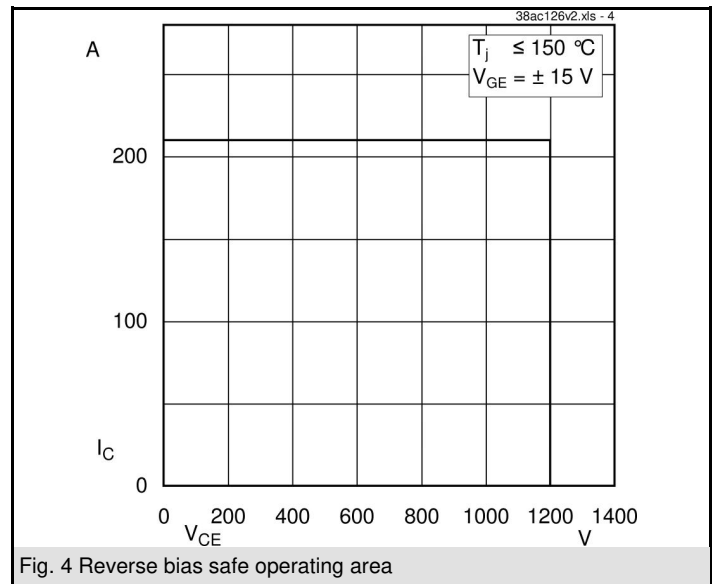
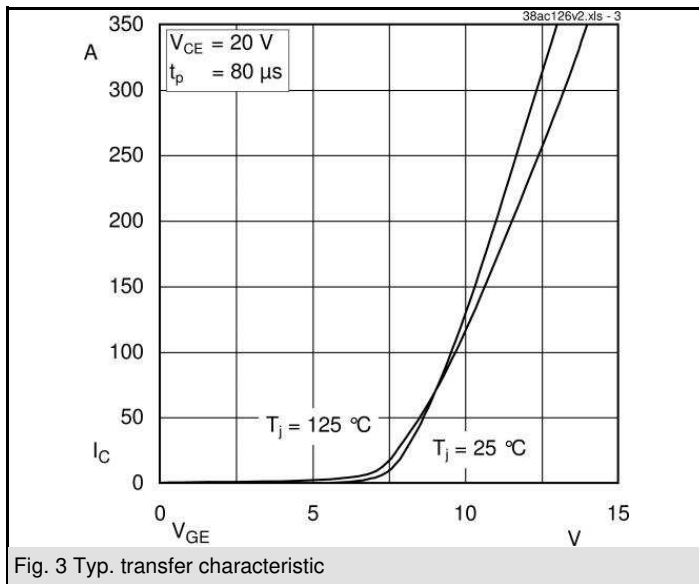
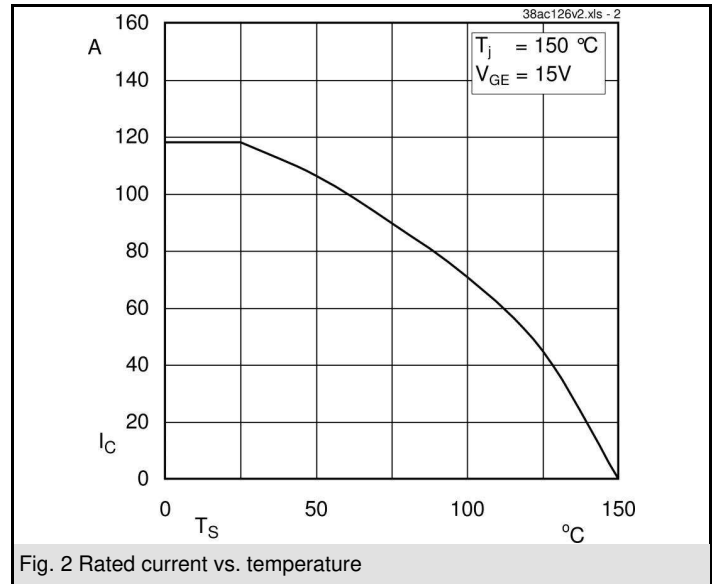
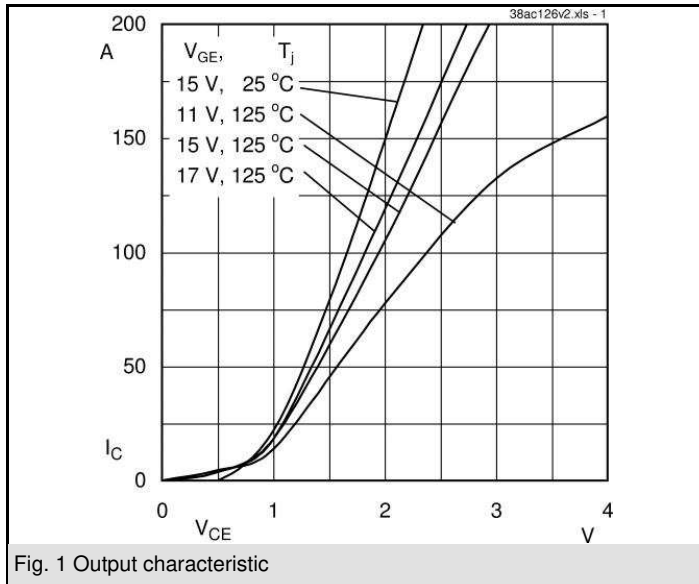

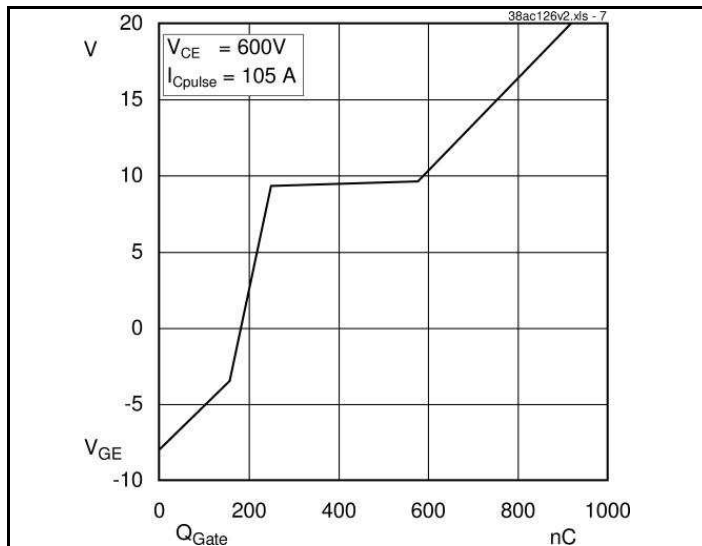

Fig. 7 Typ. gate charge characteristic

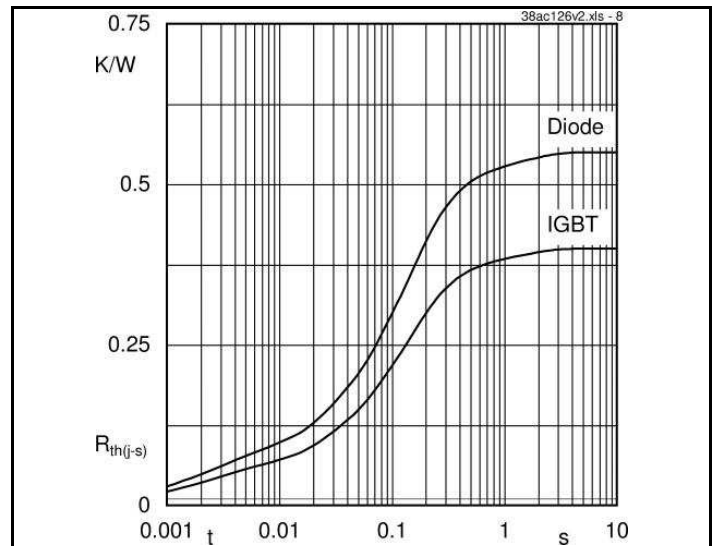

Fig. 8 Typ. thermal impedance

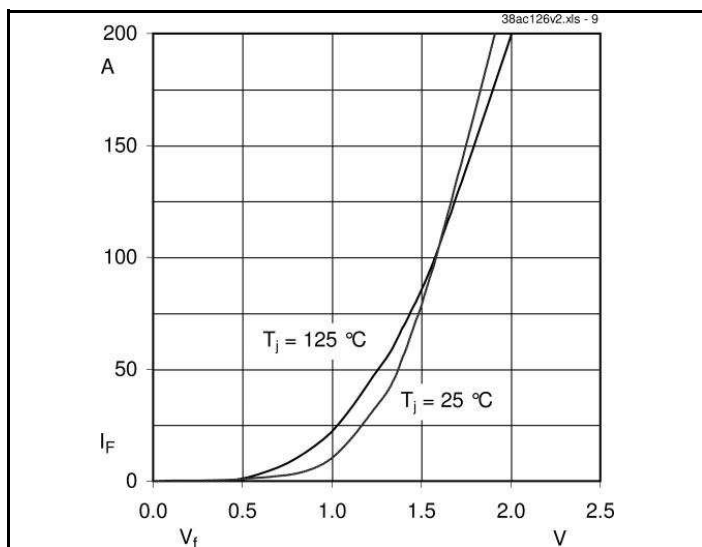
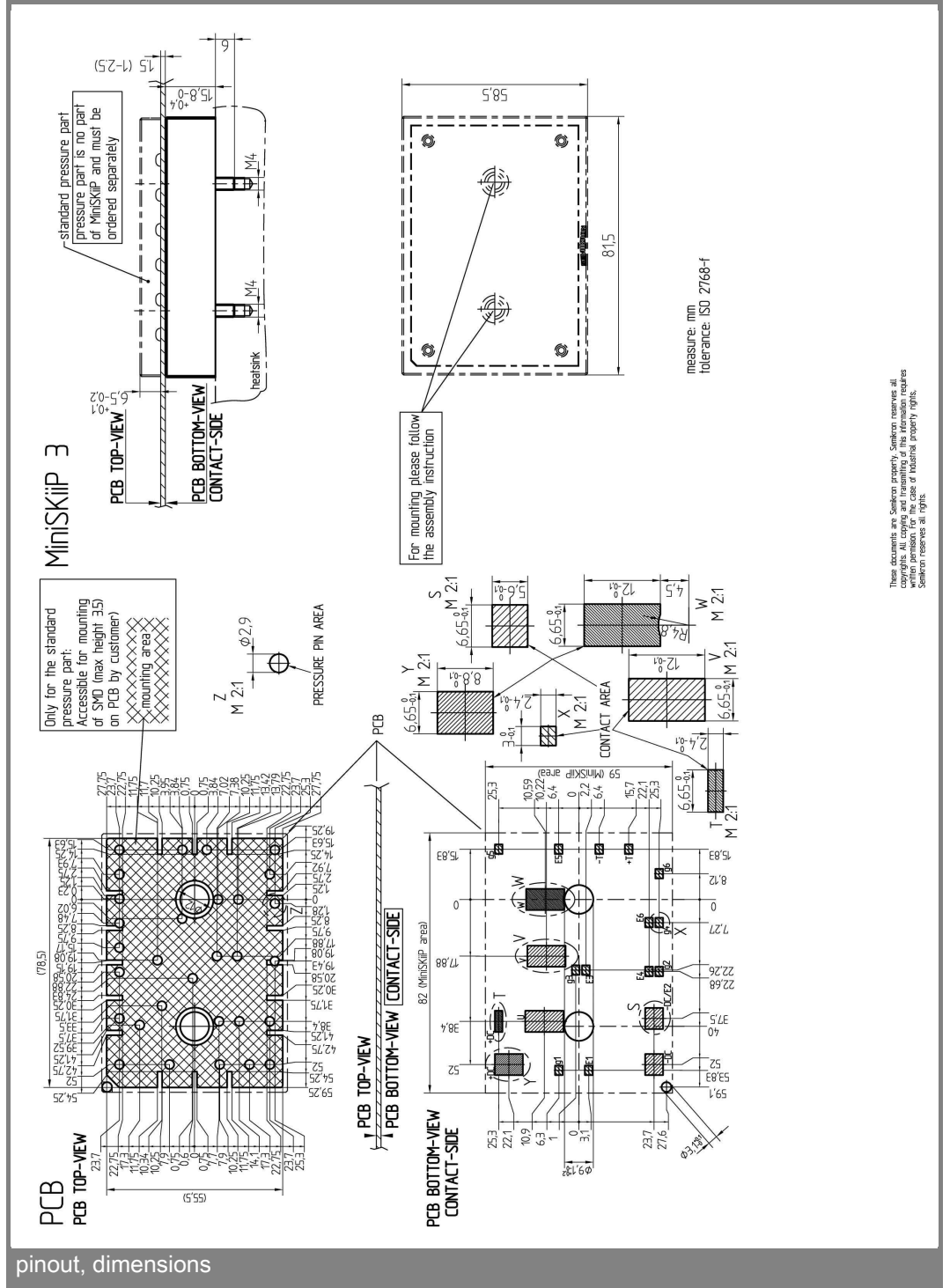
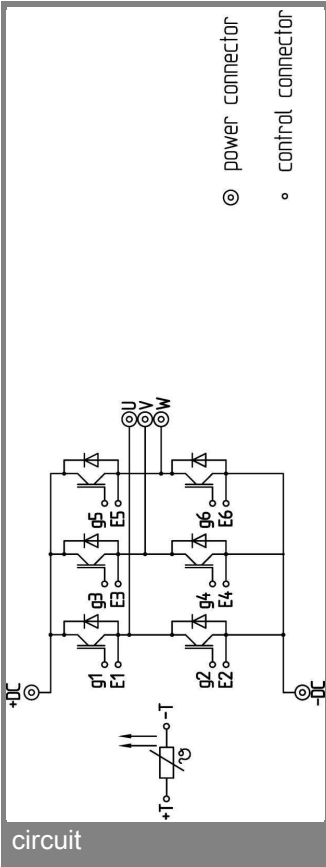

Fig. 9 Typ. freewheeling diode forward characteristic



This is an electrostatic discharge sensitive device (ESDS), international standard IEC 60747-1, Chapter IX.

* The specifications of our components may not be considered as an assurance of component characteristics. Components have to be tested for the respective application. Adjustments may be necessary. The use of SEMIKRON products in life support appliances and systems is subject to prior specification and written approval by SEMIKRON. We therefore strongly recommend prior consultation of our personal.